

Hitachi Appliances Environmental Report 2017



Aiming to become a global company that contributes to the global environment and delivers life innovation

These days, issues concerning global warming and biodiversity, a worsening water environment, waste, and recycling issues, and other environmental issues are coming to the surface, and it is becoming necessary to tackle these challenges on a global scale.

Regarding the issues of global warming, the Paris Agreement was adopted at the 21st Session (COP 21) of the 2015 United Nations Framework Convention on Climate Change (UNFCCC) designed to protect our climate today and tomorrow. The Paris Agreement, as a new framework for 2020 and later years, is a historic agreement that will bring great reforms in energy, the basis for our lives and economic activities, and came into official effect last November (2016). Based on that agreement, it was decided that the international community as a whole would work to control global warming, aiming to keep the rise in average global temperature since the Industrial Revolution at a level lower than 2 degrees. Moreover, the 2030 Agenda for Sustainable Development adopted in 2015 presented 17 Sustainable Development Goals (SDGs), including climate change, protection of marine resources, and protection of land ecosystems, thereby indicating the international community's intention to work on long-term sustainable development.

To settle environmental issues, it is imperative for companies to make positive efforts and also fulfill their social responsibility. In the SDGs, companies are positioned as one of the main implementers. In view of the above, the Hitachi Group reviewed Environmental Vision 2025, which it had thus far promoted, and in 2016 set up a new set of long-term environmental

targets—Hitachi Environmental Innovation 2050. In that set of long-term environmental targets, the Hitachi Group aims to build a low-carbon society, a resource efficient society, and a society harmonized with nature. The Hitachi Appliances Group, as a member of the Hitachi Group, joins forces with its affiliates both in and outside Japan, positively working to achieve those goals.

At the Hitachi Appliances Group, we provide solutions through large home electronics, lighting and residential equipment, and refrigeration and air-conditioning equipment to offer new value to people's lives. We also utilize advanced technologies such as IoT (which links everything to the Internet), artificial intelligence and big data, and will promote the development of new services that provide not only tangible value in the form of product functions but also value on Quality of Life, which offers solution to issues.

By providing our customers throughout the world with products and services featuring advanced energy conservation performance and highly value-added functions, we embody the Hitachi Group's corporate mission of "contributing to society through the development of superior, original technologies and products," wishing to build a sustainable, safe, and worthwhile future on the earth. Through our leading-edge technology, we then help conserve the global environment and work to become a global company that achieves life innovation.

We also hope that this report, which presents our environmental efforts, will prove to be an effective environmental communication tool for you.

conserving



Toshiaki Tokunaga
President and Director

Toshiaki Tokunaga

Contents

Message from the President	1
Hitachi Group's Environmental Vision	3
Hitachi Appliances' Environmental Activity Report	3
I. Environmental Management	3
II. Environmental Efforts in Products	5
Assessment of Design for Environment (DfE) and lifecycle assessment	5
Contribution to controls on CO ₂ emissions in the use of products by energy conservation	5
Response to the recycling of home electronics	6
Control of chemical substances contained in products	6
Products ecologically designed and developed	7
III. Efforts to Address the Environmental Issues	9
Prevention of global warming in the production process	9
Reducing the amount of waste generated in the production process	9
Reducing water consumption in the production process	10
Control of chemical substances in the production process	10
Appropriate controls on PCB-contained equipment	10
Ecosystem conservation	11
IV. Social Contribution Activities on Environment	12
V. Environmental Communications	13
Corporate Overview	14

As such environmental issues as global warming, the depletion of environmental resources, and ecosystem destruction are becoming increasingly serious, there are ever-increasing demands and expectations for companies to reduce their environmental burden. Under these circumstances and its own managerial policy, the Hitachi Group set up an Environmental Vision to clarify the image of an environmental management the Hitachi Group aims to build on a long-term basis. To realize a low-carbon society, a resource efficient society, and a society harmonized with nature, which together constitute the image of a society shown in the Environmental Vision, the Group has its set of long-term environmental targets—Hitachi Environmental Innovation 2050.



* Hitachi Environmental Innovation 2050 indicates reduction targets for CO₂ emissions in absolute terms.

In its Hitachi Environmental Innovation 2050, the Hitachi Group set reduction targets for CO₂ emissions designed to build a low-carbon society in order to meet the targets of the Paris Agreement adopted in 2015. To achieve these targets through its entire value chain, the Hitachi Group will reduce its emissions in the use stage of products, which accounts for the highest percentage of CO₂ emissions. The Group will also reduce its CO₂ emissions in the production stage from the industrial activities of each of its member companies.

Aiming to build a resource efficient society, the Hitachi Group will increase the usage efficiency of water and other resources that it consumes. To fulfill that goal, it will promote the creative manufacturing of long-lasting, resource-saving products, the thorough recycling of products, the reduction of water consumption in the production process, and other activities.

Aiming to build a society harmonized with nature, the Hitachi Group will assess the effects of its own industrial activities in each stage of its value chain on ecosystems, and promote measures to minimize its burden. It will supply products and services for those purposes, while working to minimize its environmental burden in factories and offices, and otherwise working to conserve ecosystems.

The Hitachi Appliances Group will promote the development of highly energy-saving products and environmentally conscious manufacturing, aiming to fulfill the Environmental Vision as a member of the Hitachi Group.

We will report the Hitachi Appliances Group's environmental conservation activities aiming to realize the Hitachi Group's Environmental Vision.

I. Environmental Management

② Hitachi Appliances' Environmental Conservation Guidelines

The Hitachi Appliances Group set its Hitachi Appliances' Environmental Conservation Guidelines (hereafter, "Environmental Conservation Guidelines"), which present its environmental conservation efforts regarding its industrial activities, and has been presenting the Environmental Conservation Guidelines to parties both inside and outside the Group.

Purpose

In order to realize an environmentally harmonious and sustainable society through products and services, Hitachi Appliances is committed to meeting its social responsibilities by promoting globally-applicable "MONOZUKURI" (designing, manufacturing or repairing of products), which is aimed at reducing environmental burdens of products throughout their entire life cycles, ensuring global environmental conservation.

Action Guidelines

- Global environmental conservation is a critical challenge shared by all humans. Hitachi Appliances is committed, therefore, to fulfilling its responsibilities by assisting in the realization of an environmentally harmonious and sustainable society as one of its management priorities.
- Hitachi Appliances will make efforts to contribute to society by developing highly reliable technologies and production processes, while identifying needs considering concerns related to the prevention of global warming, conservation of resources, and preservation of ecosystem.
- Members of the board in charge of environmental conservation are responsible for facilitating appropriate environmental conservation activities. Departments responsible for environmental conservation should endeavor to promote and ensure environmental conservation activities, including improving environment-related rules and regulations and setting goals for environmental burden reduction. These departments should also confirm that their environmental conservation activities are conducted in a proper manner and ensure that these activities are maintained and improved.
- Hitachi Appliances will promote globally-applicable "MONOZUKURI" with the aim of understanding and reducing environmental burdens at every stage, including product research and development, design, production, distribution, sales, usage, and final disposal.
- Hitachi Appliances will investigate and review the environmental impact caused in the course of its "MONOZUKURI" processes. Hitachi Appliances will also introduce excellent technologies and materials useful to safeguard the environment, in other words, to reduce environmental burdens through energy and resource saving, recycling, chemical substance management, consideration of ecosystem, and other measures.
- Hitachi Appliances' environmental conservation efforts are not only to be focused on observing international environmental regulations and those of national and local governments, but also on conserving the environment by implementing voluntary environmental standards when necessary.
- Regarding globally-applicable "MONOZUKURI" activities, impact on the local environment and community are to be considered. In addition, measures that meet local communities' requests should be implemented.
- Hitachi Appliances will educate its employees to take action in order to obey environment-related laws, raise their global environmental awareness, and encourage their interest in environmental conservation having wide-view about society activities.
- Hitachi Appliances will evaluate potential environmental problems and prevent them from occurring. In the event that any environmental problem occurs, Hitachi Appliances will take appropriate measures to minimize the environmental burden.
- Hitachi Appliances will make efforts to disclose information on its environmental conservation activities to its relevant stakeholders. Hitachi Appliances will also actively communicate with these stakeholders so as to strengthen mutual understanding and forge cooperative relationships with them.

I. Environmental Management

③ Hitachi Appliances Group's Environmental Action Plan 2018

To promote its activities according to the Action Guidelines for Environmental Conservation, the Hitachi Appliances Group makes a specific action plan every three years. The Hitachi Appliances Group's Environmental Action Plan 2018 (hereafter, "Environmental Action Plan 2018"), which it made in fiscal 2016, sets detailed activity items and targets to be addressed between fiscal 2016 and 2018.

Results and targets of the Environmental Action Plan 2018

In fiscal 2016, the first year of Environmental Action Plan 2018, the Group could not achieve the target of promoting water usage efficiency, but did achieve its targets in the other items. It will continue to improve its activities in achieving its targets toward the final fiscal year of 2018.

Management

Item	Indicator	Target for FY 2016	Result for FY 2016	Achievement	Target for FY 2017	Target for final fiscal year (2018)	Reference page
Reinforce global environmental management	Voluntary implementation rate of environmental audit by factory outside Japan (number of implementing factories / number of target factories)	100%	100%	◆◆◆	100%	100%	P4
Increase the environmental level	Green points (GPs) in environmental activity level indicator (GREEN21 - 2018)	240GP	284GP	◆◆◆	360GP	480GP	P5

Products and services

Item	Indicator	Target for FY 2016	Result for FY 2016	Achievement	Target for FY 2017	Target for final fiscal year (2018)	Reference page
Increase environmental performance	Reduction rate of CO ₂ emissions as used in products/services (from fiscal 2010)	19%	21%	◆◆◆	21%	22%	P5

Prevention of global warming—prevention of global warming in the production process

Item	Indicator	Target for FY 2016	Result for FY 2016	Achievement	Target for FY 2017	Target for final fiscal year (2018)	Reference page
Reduction in energy consumption	Rise in energy consumption per unit (from FY 2005)	32%	35%	◆◆◆	35%	36%	P4

Resource recycling—reduction of waste generation in the production process

Item	Indicator	Target for FY 2016	Result for FY 2016	Achievement	Target for FY 2017	Target for final fiscal year (2018)	Reference page
Control of waste generation	Rise in the amount of waste and valuable materials generated per unit (from FY 2005)	7%	14%	◆◆◆	15%	17%	P9

Resource recycling—reduction of water consumption in the production process

Item	Indicator	Target for FY 2016	Result for FY 2016	Achievement	Target for FY 2017	Target for final fiscal year (2018)	Reference page
Promotion of water use efficiency	Rise in water consumption per unit (from FY 2005)	36%	23%	◆	29%	31%	P10

Control of chemical substances—control of chemical substances in the production process

Item	Indicator	Target for FY 2016	Result for FY 2016	Achievement	Target for FY 2017	Target for final fiscal year (2018)	Reference page
Reduction of chemical substance emissions	Rise in energy consumption per unit in chemical substance emissions into the atmosphere (from FY 2006)	19%	27%	◆◆◆	17%	17%	P10

Ecosystem conservation

Item	Indicator	Target for FY 2016	Result for FY 2016	Achievement	Target for FY 2017	Target for final fiscal year (2018)	Reference page
Contribution to ecosystem conservation	Number of new ecosystem conservation projects carried out	2	5	◆◆◆	2	2	P11

Collaboration with stakeholders

Item	Indicator	Target for FY 2016	Result for FY 2016	Achievement	Target for FY 2017	Target for final fiscal year (2018)	Reference page
Promotion of environmental contribution to society	Number of environmental training, information exchange, greening and other ecosystem conservation, cleaning and other community services, reduced use of lighting, energy conservation with the community, etc. carried out	32	38	◆◆◆	64 (cumulatively from FY 2016)	95 (cumulatively from FY 2016)	P12

[Criteria of assessment] ◆◆◆: achieved ◆◆: achieved 80% or more ◆: achieved less than 80%

③ Environmental management structure

The Hitachi Appliances Group convenes the Environmental Management Officer Meeting consisting of the Environmental Strategy Officer in charge of supervising the environmental activities of the entire Group and Environmental Management Officers of the main factories and Group companies both in and outside Japan four times a year. This Environmental Management Officer Meeting deliberates and determines environmental principles and targets for the Hitachi Appliances Group. Based on decisions made by the Environmental Management Officer Meeting, the Environment Promotion Department collaborates with Business Divisions and Management Divisions to promote environmental conservation.

To promote environmental conservation positively, the Group has established an environmental management system as per the international standard ISO 14001 at factories with heavy environmental burdens, and all manufacturing and recycling centers both in and outside Japan have been certified under the standard by outside agencies.

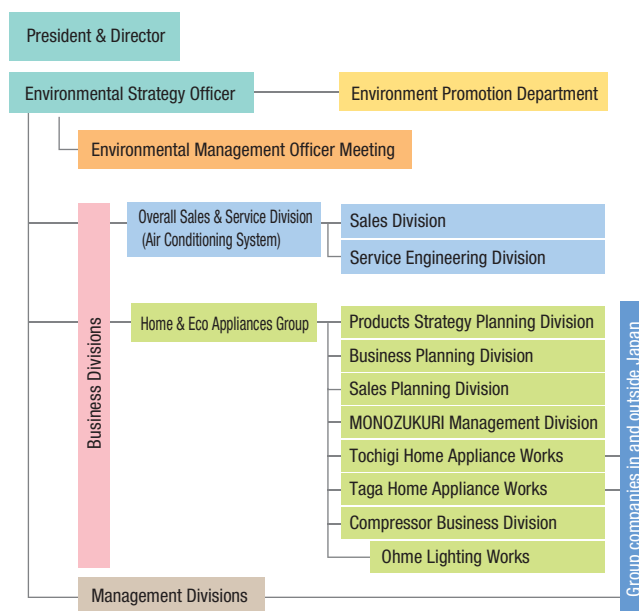

(As of April 1, 2017)

③ Environmental internal audit

The Hitachi Appliances Group aims to improve its business operations and environmental practices, while conducting internal environmental audits of its factories (three factories in Japan and three Group companies outside Japan) every year in order to prevent environmental problems. These audits are conducted by a team of auditors, who are environmental representatives of the head office's Environmental Dept. and those of factories other than the factories to be audited, and this team verifies and assesses whether environmental management at each factory is performed appropriately and reasonably as per relevant laws, corporate rules, and Environmental Action Plan 2018.

The internal environmental audit of fiscal 2016 identified 12 items to be improved. Six main items were identified concerning the reduction of environmental risk, and four items concerning the reinforcement of environmental compliance. For the items identified, each factory has set up an improvement plan and is working to make improvements.

I. Environmental Management

③ Assessment program for environmental activities

To better its level of environmental practices, the Hitachi Group implements GREEN21, which assesses environmental activities by certain criteria for each factory. GREEN21 is an assessment program peculiar to the Hitachi Group that divides the targets of the environmental action plan into six categories, and assesses how much has been achieved. Settings are made so that each assessment item is evaluated on a scale of 1 to 5, and that each category runs on a full scale of 100 green points (GPs) or 600 GPs in total. Results are visualized on a radar chart, which allows you to reconfirm the strengths and weaknesses of each factory, thereby further activating improvements and activities.

The total score of the Hitachi Appliances Group in fiscal 2016 in terms of GREEN21 was 284 GPs, compared with its target of 240 GPs, so that the Group surpassed its target. The targets were far exceeded in the categories of management, recycling of resources, and control of chemical substances. The present project showed high scores for the category of management because environmental audits were conducted of all the Group companies outside Japan. The success in the categories of resource recycling and control of chemical substances is due to a great achievement in meeting the targets for the recycling rate and the rise in the amount of waste and valuable materials generated per unit. The Group intends to further step up its efforts in an attempt to achieve its goal of 360 GPs for fiscal 2017 and its goal of 480 GPs for fiscal 2018.

Assessment items for GREEN21

	Category	Main assessment items
1	Management	Environmental management and observation of laws and regulations
2	Products and services	Improvement of environmental performance and assessment of Design for Environment (DfE)
3	Prevention of global warming	Rise in energy consumption per unit, energy conservation in transportation
4	Recycling of resources and control of chemical substances	Improvement ratio in the amount of waste and valuable materials generated per unit Improvement ratio in the water consumption per unit Improvement ratio in the atmospheric emissions of chemical substances per unit
5	Ecosystem conservation	Number of ecosystem conservation activities carried out
6	Collaboration with stakeholders	Number of social contribution activities on environment

Fiscal 2016 targets and results in the green point averages of the Hitachi Appliances Group

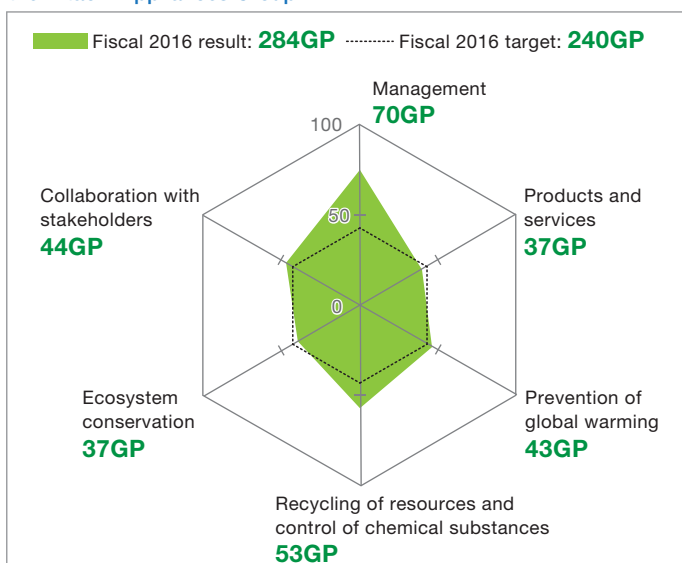

Data gathered: Tochigi Works, Taga Works, and Ohme Works
Shanghai Hitachi Household Appliances Co., Ltd.
Hitachi Compressor (Thailand), Ltd.
Hitachi Consumer Products (Thailand), Ltd.

II. Environmental Efforts in Products

③ Assessment of Design for Environment (DfE) and lifecycle assessment

The Hitachi Appliances Group conducts an assessment of Design for Environment (DfE) regarding changes in environmental impacts and changes in environmental aspects that accompany achieving development targets throughout the lifecycle of a specific product when the product is designed and developed, in order to realize environmentally friendly products as a member of the Hitachi Group. This assessment aims to assess a total of 30 environmental aspects that affect climate change, resource depletion, and environmental contamination (ecosystem deterioration) in different stages of the lifecycle of a specific product, thereby working to reduce its environmental burden.

Moreover, to satisfy the requirements for DfE as defined in IEC 62430,^{*1} the Group has incorporated into the environmental management system (certified under ISO 14001^{*2}) the assessment of DfE and the monitoring of environmental controls and stakeholder needs for the environment, and their incorporation into design and development, and other processes of DfE.

The Group also conducts lifecycle assessment (LCA), which quantitatively assesses the environmental burden of products throughout their lifecycles, which will become the main factor that affects climate change and other global environmental issues, and uses the findings in calculating the emissions of greenhouse gases through the value chain of the Hitachi Group.

*1: The standard "Design for Environment of Electrical and Electronic Products" of the International Electrotechnical Commission.

*2: The standard "Environmental Management System—Requirements" of the International Organization for Standardization (ISO).

③ Contribution to controls on CO₂ emissions in the use of products by energy conservation

The Hitachi Appliances Group is committed to increasing the environmental performance of its products by promoting energy conservation, in order to develop and spread environmentally friendly products as a member of the Hitachi Group, thereby helping to address environmental issues. To combine functional enhancement with a reduction of environmental burden, the Group works to reduce CO₂ emissions (power consumption) in the use of its products by using a reduction rate per function as the indicator. More specifically, it positively achieves the following:

- (1) reduces power consumption when two functions are of the same function, and
- (2) improves functionality when two products consume the same power, thereby reducing CO₂ emissions in the use of products.

For products that contribute the most to controls on CO₂ emissions (i.e., refrigerators, washers, LED lights, heat pump water heaters), the Group in fiscal 2016 promoted Design for Environment (DfE) in the design and development of products, and increased the sales of highly energy-saving products, thereby increasing the reduction rates of CO₂ emissions (i.e., reduction rates of power consumption per functional quantity) by about 21% from the rates of fiscal 2010 products.

Reduction rates of CO₂ emissions in the use of four products contributing the most to controls on CO₂ emissions (i.e., refrigerators, washers, LED lights, heat pump water heaters)

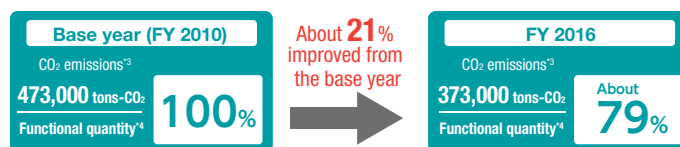

*3: CO₂ emissions on the assumption that the required number of units were used to obtain a functional quantity comparable to that of products from the fiscal year assessed.

*4: Among the main functions of products, the function correlated with CO₂ emissions.

II. Environmental Efforts in Products

④ Response to the recycling of home electronics

In response to the Act on Recycling of Specified Kinds of Home Appliances, in 1999 the Hitachi Appliances Group established Kanto Eco Recycle Co., Ltd.—a company for recycling four types of end-of-life home appliances⁵— on the premises of the Tochigi Works. This recycling factory is integral with the production factory, and information obtained from this factory is fed back to product design and used to increase recycling rates.⁶ Kanto Eco Recycle Co. collaborates with five similar companies⁷ in developing recycling technology and operating an efficient nationwide recycling system.

The end-of-life home appliances recycled by the recycling company in fiscal 2016, in the two-item sum of refrigerators/freezers and washers/driers, numbered about 1,139,000 units and weighed about 45,000 tons. Both items exceeded their respective legal recycling rates.

⁵: Room air-conditioners, refrigerators/freezers, washers/driers, TVs (cathode ray tube, liquid, and plasma types).

⁶: Among end-of-life home appliances taken in by their manufacturers, etc., the percentages of those transferred as parts or raw materials for a fee or free of charge are evaluated in weight.

⁷: Sharp Corporation, Sony Corporation, Fujitsu General Limited, Mitsubishi Electric Corporation, and Hitachi Appliances, Inc. (five companies in total)

End-of-life home appliances recycled by Hitachi Appliances, Inc. in 2016

Item	Refrigerators/freezers	Washers/driers	Total
Number of units recycled (in thousands)	383	756	1,139
Processing weight of recycled units [A] (tons)	23,445	28,305	51,750
Weight of recycled material [B] (tons)	19,075	26,596	45,671
Recycling rate [A/B] (%)	81	93	—
Legal recycling rate (%)	70	82	—

Breakdown of weight of products recycled

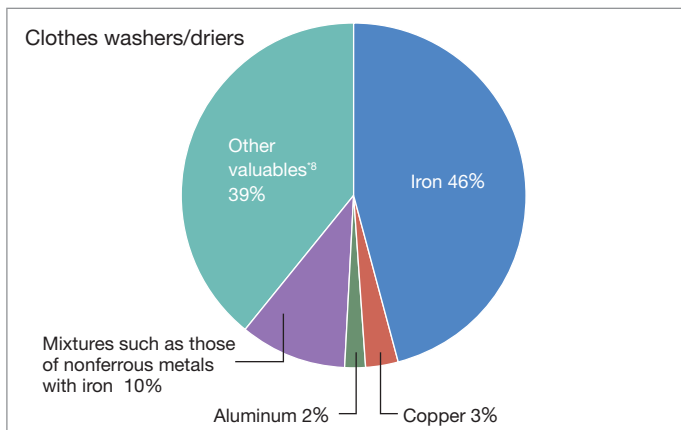
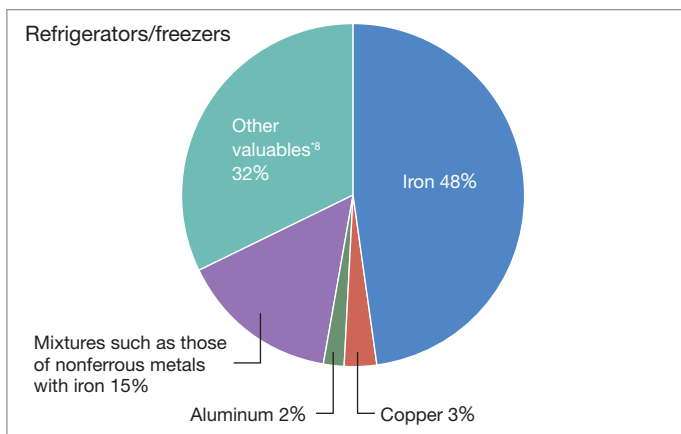

*8: Other valuables mainly consist of plastics.

④ Control of chemical substances contained in products

With its Environmental CSR-compliant MONOZUKURI Standards, the Hitachi Appliances Group controls chemical substances contained in its products during the stages of development and design, procurement, and manufacture. Of all those stages, the most important stage—control of chemical substances in procuring materials, parts, and other objects—is performed according to the Hitachi Group Green Procurement Guidelines disclosed by the Hitachi Group, and strictly controls chemical substances contained in products. These guidelines consider 18 chemical substances prohibited by laws and regulations both in and outside Japan as prohibited substances, monitors the realities of their use, designates the 27 chemical substances to be properly controlled as controlled substances, and controls them as voluntarily controlled chemical substances.

In collecting information about the inclusion of chemical substances, the Group cooperates with its suppliers in investigating the content rates of chemical substances to be voluntarily controlled not only for parts to be incorporated in products but also for all members purchased for production, such as oils used in the manufacturing process, thereby completing the investigation by the time the first lot of products is shipped. Moreover, inclusion information obtained in the survey is centrally controlled and shared in the form of a database with related departments.

Trends in reinforcing regulations for chemical substances, pioneered by RoHS⁹ Directives from the European Union, are becoming widespread in various countries. In China as well, what is called the “Chinese RoHS” has been revised and extended to a wider range of products. In other Asian countries, laws comparable to RoHS are also being established. Moreover, the EU’s RoHS Directive has also been revised (in June 2015) to announce that four phthalic esters would be additionally prohibited in July 2019. The Hitachi Appliances Group is also responding to that trend accordingly in controlling those substances as prohibited ones.

In response to the increasingly strict restrictions in various countries, the Hitachi Appliances Group is working positively to control chemical substances contained in MONOZUKURI (creative manufacturing) that goes global.

*9: Short for “Restriction of Hazardous Substances.” A regulation on dangerous substances.

Prohibited substances (18 substances)

No.	Chemical substance	No.	Chemical substance
1	Cadmium and its compounds	11	Short chain chlorinated paraffin
2	Hexavalent chromium compounds	12	Asbestos
3	Lead and its compounds	13	Ozone depleting substances (Class I)
4	Mercury and its compounds	14	PFOS and PFOS-analogous compounds
5	Polybrominated biphenyls (PBBs)	15	2-(2H-1,2,3-benzotriazol-2-yl)-4,6-di-tert-butylphenol
6	Polybrominated diphenyl esters (PBDEs)	16	Hexachlorobenzene
7	Tri-substituted organostannic compounds	17	Dimethyl fumarate (DMF)
8	Polychlorinated biphenyls (PCBs)	18	Hexabromocyclododecane (HBCD or HBCDD)
9	Polychlorinated terphenyls (PCTs)		
10	Polychlorinated naphthalene (with 2 or more chlorines)		

Controlled substances (27 substances)

No.	Chemical substance	No.	Chemical substance
1	Bis (2-ethylhexyl) phthalate (DEHP)	16	Cobalt and its compounds
2	Butyl benzyl phthalate (BBP)	17	Azo dyes and pigments that form designated amines
3	Dibutyl phthalate (DBP)	18	Formaldehyde
4	Diisobutyl phthalate (DIBP)	19	Benzene
5	Antimony and its compounds	20	Fluorine-based greenhouse gases
6	Arsenic and its compounds	21	Polycyclic aromatic hydrocarbons (PAHs) corresponding to REACH-restricted substances
7	Beryllium and its compounds	22	Perfluorooctanoic acid (PFOA) and its salts and esters
8	Nickel and its compounds		
9	Selene and its compounds		
10	Unspecified bromine-based flame retardants	23	Benzene amine, N-phenyl-, reaction products with styrene and 2,4,4-trimethylpentene, (BNST)
11	Polyvinyl chlorides (PVCs) and mixtures and copolymers thereof	24	REACH-restricted substances
12	Phthalic esters other than Nos. 1 to 4 in this table	25	REACH-certified substances
13	Ozone depleting substances (Class II: HCFC)	26	REACH SVHC
14	Radioactive substances	27	Substances controlled by the Joint Article Management Promotion-consortium (JAMP)
15	Di-substituted organostannic compounds (e.g., DBTs, DOTs)		

II. Environmental Efforts in Products

Products ecologically designed and developed

The following are examples of environmentally friendly products developed by assessment of Design for Environment (DFE) and lifecycle assessment (LCA).

Refrigerators

Large-capacity refrigerators: Vacuum Chilled

While pursuing larger capacities, we have adopted Hitachi's unique frost-recycle cooling and several other energy conservation technologies to further reduce^{*10} power consumption.



R-XG6700G (XT)

Energy conservation technology

Frost Recycling Cooling Technology

This technology stops the compressor and allows the force of frost stuck to the cooler to cool down the refrigeration and vegetable compartments during operation. A rise in frost temperature shortens the defrosting time, thereby reducing power consumption.

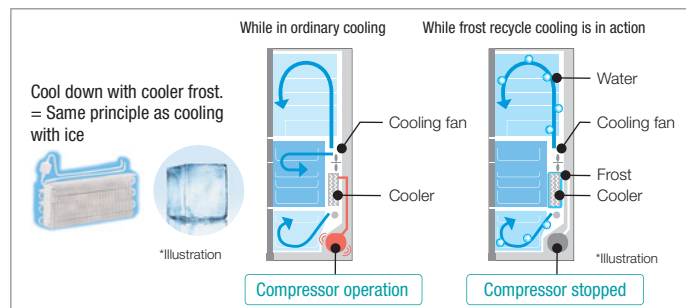

Frost Recycling Cooling Technology

Vacuum insulator

Foamed polyurethane, which has been used as an insulator, is combined with a vacuum insulator having high insulating efficiency, thereby combining large capacity with energy conservation.



*Different models have vacuum insulators at different locations, with different shapes and quantities.

Consideration of controls on global warming

HFC-free polyurethane insulator and HFC-free refrigerant

The insulator portion other than the vacuum insulator is made of a hard polyurethane insulator based on a HFC-free foaming gas (cyclopentane) as an environmentally friendly foaming agent. It is also based on a HFC-free refrigerant (R600a), which affects the status of global warming less than the alternative HFC refrigerant (R134a).

*10: Comparison of the conventional R-X6700F model with annual power consumption of 366 kWh and a rated internal volume of 665 L (FY2015 product) and the R-X6700G model with annual power consumption of 330 kWh and a rated internal volume of 670 L. As per JIS C 9801-3: 2015.

Washers/driers

Drum-type washers/driers: Big Drum

Heat-recycle drying, powerful circulating pump, and various other technologies^{*11} are used to reduce^{*12} both power consumption and water consumption.



BD-NX120AL (N)

Energy conservation technology

Heat-recycle drying

Recycles air heat by Eco Flap.

The heat of air heated by the main motor and heater is taken in through an open Eco Flap (an openable air intake port) installed midway in the dry air passage, and then is recycled as hot air in drying.

Recycles the heat of the jet fan.

In addition to the heat of the heater, the compression heat from the jet fan that generates a fast air stream and the heat of the jet fan motor are used as a hot air stream in drying.

Recycles the heat of the main motor.

The heat generated by the main motor is conveyed to the drum to heat the drum.

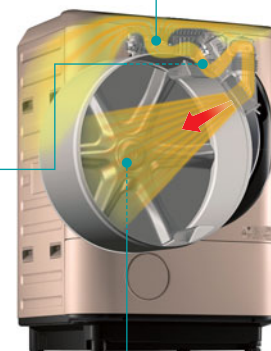

*Illustration

Water conservation technology

Powerful circulating pump, rinsing with rotary spray

A reduced amount of water from the powerful circulating pump is used for washing. Rinsing with rotary spray is performed to apply a little water combined with centrifugal force to remove detergent effectively, thereby saving water (with the subsequent rinsing operation using the stored water).

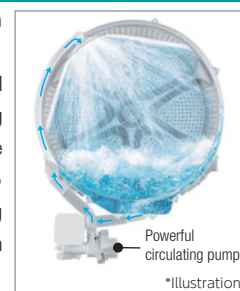

*Illustration

Large-capacity weight reduction

The five-ply fluid balancer, which reduces vibration amplitude while the drum is turning, and other low-vibration technologies are used together with material thinning and weight reduction of the wash tank. With the outside dimensions of the product remaining similar to those of the conventional model BD-V9800 (FY2015 product), the washing and dewatering capacity increased from 11 kg to 12 kg, while product weight is reduced from about 83 kg to about 82 kg to combine larger capacity with lighter weight.

*11: Heat cycle drying, air stream iron, powerful circulating pump, and rinsing with rotary spray.

*12: Comparison of the BD-V1500 (FY2012 product not equipped with this function) with power consumption of about 1,930 Wh and water consumption of about 96 L and the BD-NX120A with power consumption of about 980 Wh and water consumption of about 54 L when washing and drying 6-kg clothes in the standard course. The data is based on the assessment as per the Japan Electrical Manufacturers' Association's voluntary standard ("Method for Assessing Drying Performance").

II. Environmental Efforts in Products

Products ecologically designed and developed

Household pumps

Bladder-type^{*13} combined shallow/deep^{*14} use inverter pumps: Smart Tsuyoshi

Equipped with an efficient pump head and a high-performance IPM^{*15} motor, this model saves energy^{*16} and reduces noise.^{*17}



CM-P400X

Energy conservation technology

Shape optimization by fluid analysis

An efficient pump head, based on shapes for a runner (rotary impeller) and a guide vane optimized by fluid analysis, is combined with the energy conservation and noise reduction technology of a high-performance IPM^{*15} motor for pumps only. This has reduced power consumption of the CM-P400X (with motor output of 400 W) to 680 W, down 325 W^{*16} from that of conventional model DM-P400W, and operating sound to 55 dB, down 6 dB.^{*17}

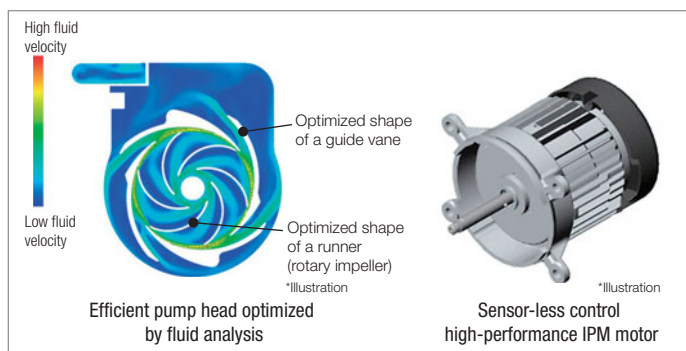

Wear-resistant technology

Wear-resistant elastic casing

The guide vane in the casing is tipped with a piece of elastomer, an elastic body. The impact energy of sand is then absorbed by the elastomer through elastic deformation to significantly reduce wear and ensure the model's long-term power.^{*18}

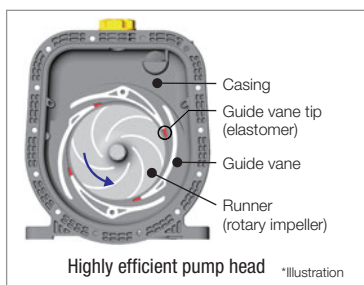

Small lightweight body

The body dimensions are made compact, with the pump head casing being changed from stainless castings to glass fiber-reinforced resin, and a soundproof/rainproof resin cover and a lightweight motor are adopted to reduce the body mass from 26 kg in conventional model DM-P400W to 14 kg, down about 45%.

- *13: A pump with a pressure tank consisting of a casing and a movable rubber film (bladder) charged with nitrogen gas.
- *14: A combined shallow/deep pump can be used not only in shallow wells with a suction head of up to 7 m but also in deep wells with suction heads more than 7 m (as different models have different peak suction heads).
- *15: Short for "Interior Permanent Magnet." An embedded magnetic rotor.
- *16: Comparison with the conventional bladder-type model DM-P400W (FY2012 product) having a rated power consumption of 1,005 W. Measured according to JIS B 8318.
- *17: Comparison with the conventional bladder-type model DM-P400W (FY2012 product) having an operating sound of 61 dB, at a suction head of 12 m. Measured according to JIS B 8310.
- *18: Based on our own investigation. As compared in wear-resistance performance with the conventional bladder-type model DM-P400W (FY2012 product), when the pump contains 100 L of water with 2 kg of 60-mesh silica sand and is continuously operated at a suction head of 0.5 m in a maximum water quantity operation (with the effect variable with water quality, installation environment, and water consumption).

LED instruments for facilities

Lighting for facilities: LED instruments for high ceilings

A high-radiation body and an efficient LED module are used to reduce size and weight, thereby achieving high energy conservation performance.



Metal halide lamp 400 class
(with a beam opening angle of 60 degrees)
MTE22ANN-J14A

Energy conservation technology

High-radiation body, efficient LED module

A radiation fin on which to install an LED light source board, and a power circuit case, are in the form of an integral part made possible by high-conductivity aluminum protrusion molding. It is thus a newly designed high-radiation body. An efficient LED module is also used to realize energy conservation performance^{*19} and the MTE22ANN-J14A has realized high consumption efficiency of 156.8 lm/V (at input power of 200 V) for characteristic energy.

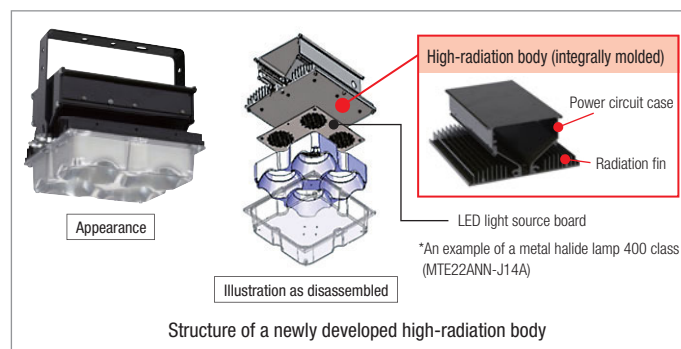

Smaller in size, lighter in weight

The MTE22ANN-J14A uses a high-radiation body made of aluminum to reduce its size to a height of 240 mm and width up to 264 mm, or about two-thirds of the conventional model's dimensions. At the same time, the power circuit case made of steel in earlier versions is now made of a combination of aluminum and resin weighing 3.3 kg, or about half of what the conventional model used to weigh.

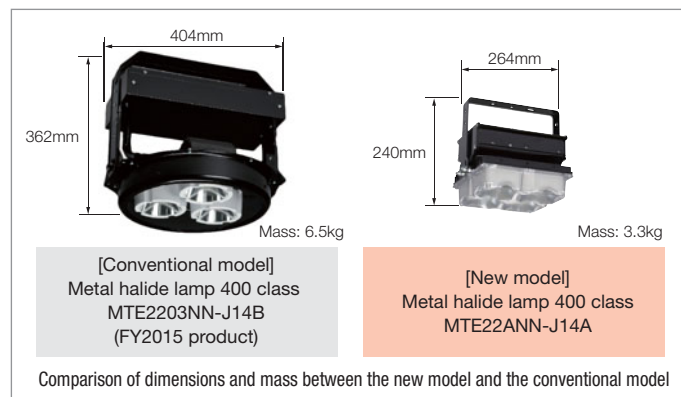

*19: Comparison with the conventional model MTE2203NN-J14B (FY2015 product) having characteristic energy consumption efficiency of 133.5 lm/W.

III. Efforts to Address the Environmental Issues

① Prevention of global warming in the production process

To help prevent global warming, the Hitachi Appliances Group promotes the efficient use of energy in production activities and is committed to reducing greenhouse gases (such as CO₂). More specifically, the Group works on this target by using the rise in energy consumption per unit¹ as its indicator.

For the energy consumption per unit in fiscal 2016, the Group met its target, achieving a rise of about 35% as compared with its targeted rise of 32% (from the base year 2005). In energy conservation to achieve its target, the Group promotes the introduction of LED lights and other efficient equipment, and works to increase equipment efficiency systematically and in other fields. Moreover, it works positively to remove waste by visualizing the status of power use.

*1: An indicator determined by dividing energy consumption (in crude oil equivalents) by the amount of activities.²

*2: A value linked closely to energy consumption (such as production in terms of amount and quantity)

Energy consumption (in crude oil equivalents) per unit

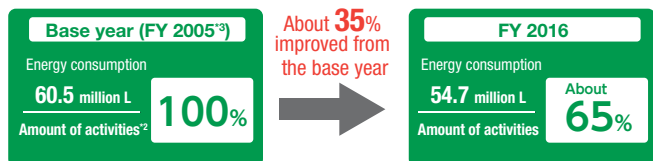

*3: As a rule, fiscal 2005 is the base year. (In case where insufficient data is available, the base year will be the first year when an inventory was created in or after fiscal 2005.)

② Reducing the amount of waste generated in the production process

Resource issues stemming from economic development and population growth are common to the whole world, and demand is high for doing something about the mass consumption of resources and the mass generation of waste. To combat these problems, the Hitachi Appliances Group promotes controls on the amounts of waste and valuable materials⁵ generated in the production process. As an indicator, it is committed to increasing the amount of waste and valuable materials generated per unit, in order to improve the efficiency of procurement and the production process.

As the amount of waste and valuable materials generated per unit in fiscal 2016, the Group met its target by achieving 14%, and thus exceeded its targeted rise of 7% (from the base year of 2005) by taking various measures. Moreover, the Taga Works and the Ohme Works achieved zero emissions,⁸ which involved reducing their quantities of landfill disposal to as close to zero as possible.

*5: Among those that became unnecessary in the production process, the resources having market value.

*6: An indicator determined by dividing the generation of waste and valuable materials by the amount of activities.⁷

*7: A value linked closely to the generation of waste and valuable materials (such as production in terms of amount and quantity)

*8: The concept of reducing the amount of landfill disposal to zero by using waste as material for different industries.

Hitachi's definition: factories with final disposal rates⁹ of 0.5% or less in the relevant fiscal year.

*9: Amount of landfill disposal / generation of waste and valuable materials.

Amount of waste and valuable materials generated per unit

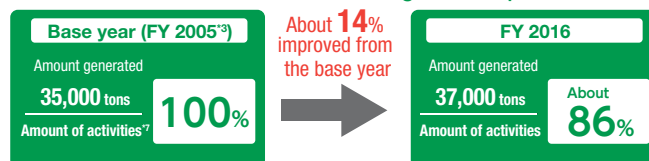

Changes in CO₂ emissions (with energy consumption in CO₂ equivalents)

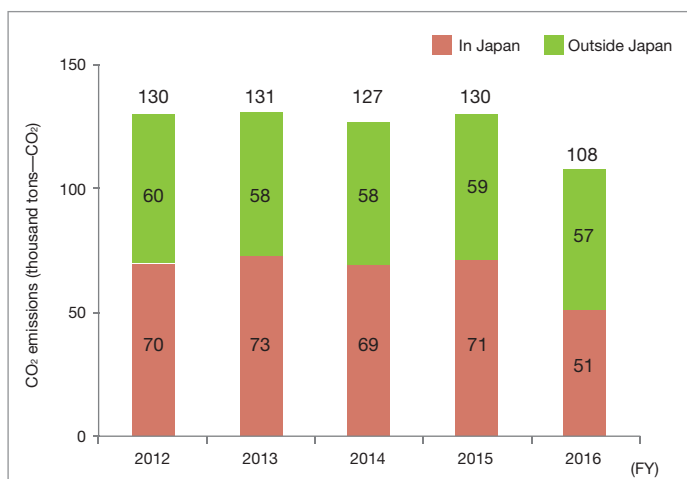

Data gathered: Tochigi Works, Taga Works,⁴ and Ohme Works
Shanghai Hitachi Household Appliances Co., Ltd.
Hitachi Compressor (Thailand), Ltd.
Hitachi Consumer Products (Thailand), Ltd.

The CO₂ conversion factor used in determining CO₂ emissions was the country-specific conversion factor in 2005 of CO₂ Emissions from Fuel Combustion (2010, International Energy Agency).

*4: Includes affiliate companies working with the above companies.

Changes in the amount of waste and valuable materials

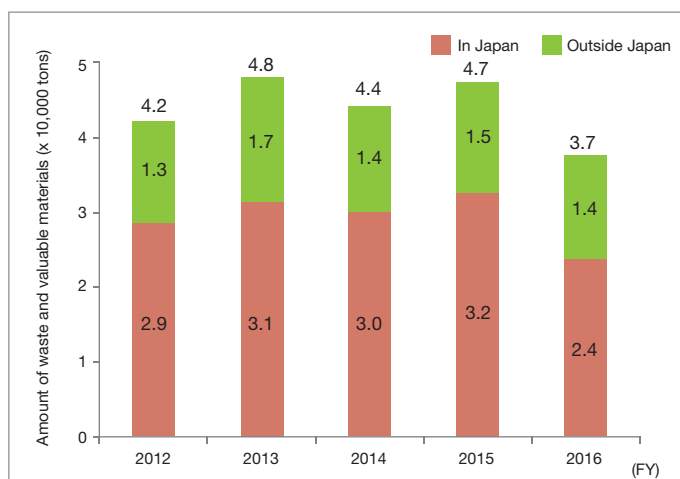

Data gathered: Tochigi Works, Taga Works,⁴ and Ohme Works
Shanghai Hitachi Household Appliances Co., Ltd.
Hitachi Compressor (Thailand), Ltd.
Hitachi Consumer Products (Thailand), Ltd.

III. Efforts to Address the Environmental Issues

② Reducing water consumption in the production process

The Hitachi Appliances Group uses water in the process including product testing, equipment cooling, and painting. Water resources face multifaceted issues such as a shortage of life service water and of agricultural water due to population growth, settlement of the ground because of underground water being pumped up, and ecosystem destruction by wastewater. To help address these issues, the Hitachi Appliances Group promotes the reduction of water consumption in its factories. As an indicator, it works on increasing the water consumption per unit^{*10} so as to increase efficiency in the production process.

The water consumption per unit in fiscal 2016 failed to meet the target, achieving only 23% as opposed to the targeted rise of 36% (from the base year of 2005). One main reason is a rise in water consumption due to water leakage from aged underground piping. In the future, the Group will identify the water leaking points and take measures to combat these water leaks by replacing the piping, thereby aiming to meet the target for fiscal 2018.

*10: An indicator determined by dividing water consumption by the amount of activities.^{*11}

*11: A value linked closely to the amount of waste and valuable materials generated (such as production in terms of amount and quantity).

Water consumption per unit

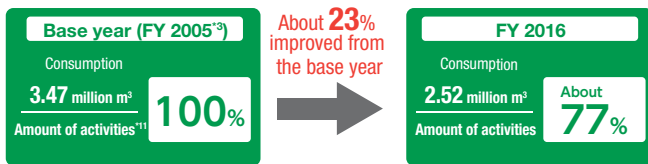

② Control of chemical substances in the production process

The Hitachi Appliances Group works to reduce its emissions of chemical substances such as VOC^{*12} from its factories in order to prevent air pollution. In fiscal 1016, it extended its control from 41 to 50 substances, thus intensifying its control.

For the atmospheric emissions of chemical substances per unit^{*13} in fiscal 2016, the Group achieved 27%, thereby meeting its targeted rise of 19% (from the base year of 2006). Its main policy in improvement was to use highly glossy polypropylene as an appearance part for drum washing machines, thereby reducing the number of painted parts. As a result, the Group managed to reduce the amount of painting coats, thereby helping reduce the atmospheric emissions of chemical substances.

The Group also monitors the emission levels of sulfur compounds (SOx) and nitrogen oxides (NOx), which are non-VOC air contaminants, thereby exercising appropriate control.

*12: Short for "Volatile Organic Compounds." These are volatile and refer generically to organic compounds that become gaseous in the atmosphere. The most representative of these compounds includes toluene, xylene, and ethanol.

*13: An indicator determined by dividing the atmospheric emissions of chemical substances by the amount of activities.^{*14}

*14: A value linked closely to atmospheric emissions of chemical substances (such as production in terms of amount and chemical substances handled).

Data gathered: Tochigi Works, Taga Works,⁴ and Ohme Works
Shanghai Hitachi Household Appliances Co., Ltd.
Hitachi Compressor (Thailand), Ltd.
Hitachi Consumer Products (Thailand), Ltd.

Atmospheric emissions of chemical substances per unit

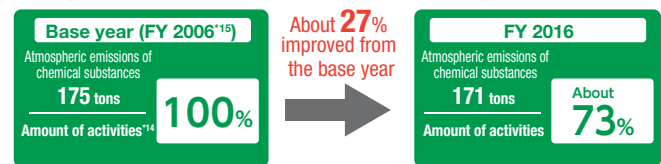

*15: As a rule, fiscal 2006 is the base year. (In case where insufficient data is available, the base year will be the first year when an inventory was created in or after fiscal 2006.)

Changes in water consumption

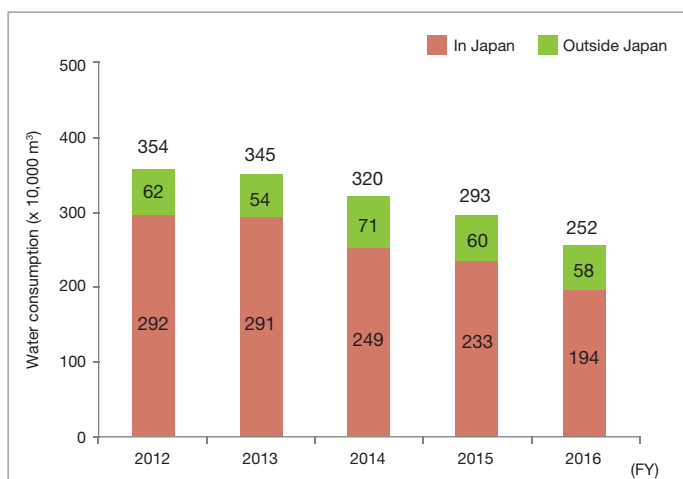

Data gathered: Tochigi Works, Taga Works,⁴ and Ohme Works
Shanghai Hitachi Household Appliances Co., Ltd.
Hitachi Compressor (Thailand), Ltd.
Hitachi Consumer Products (Thailand), Ltd.

② Appropriate controls on PCB^{*16}-contained equipment

Transformers, capacitors, fluorescent lamp stabilizers, and other equipment that previously used PCB are appropriately stored and controlled as per the Act Concerning the Disposal and Cleaning of Waste (Waste Disposal Act) and the Act on Special Measures concerning Promotion of Proper Treatment of PCB Wastes (PCB Special Measures Act).

Highly concentrated PCB waste is commissioned for disposal to Japan Environmental Storage & Safety Corporation (JESCO), an agency that disposes of PCB waste. Moreover, lowly concentrated PCB waste is commissioned to operators certified by the Ministry of the Environment for proper disposal.

In fiscal 2016, PCB waste that was previously stored at two factories^{*17} was partially disposed of. We will continue to dispose of such waste systematically and complete its processing by 2027, the legal deadline.

*16: Polychlorinated biphenyl. Given its insulation, non-combustibility, and other characteristics, polychlorinated biphenyl was previously employed in a wide range of uses that included transformers, capacitors, and other electronics. With the Kanemi Yusho incident involving contaminated rice bran oil (in 1968) as the turning point, the toxicity of the material became a social problem and its production was discontinued in 1972.

*17: Tochigi Works and Ohme Works.

III. Efforts to Address the Environmental Issues

② Ecosystem conservation

Relations between ecosystems and corporations

Our life is based on the various benefits of nature ("ecosystem services") provided by air, water, soil, animals, plants, and other natural capital. Corporate activities that provide food, industrial products, services, and other things indispensable to our lives also depend on ecosystem service. Conversely, corporate activities adversely affect ecosystems by dividing the habitats of creatures through the procurement of raw materials and land use, by dispersing introduced species while transporting materials, contaminating the atmosphere and water through factory operation, and other means. The Hitachi Appliances Group also affects ecosystems to a certain extent in all value chains, including the procurement of raw materials, product manufacturing, and use of energy for transporting materials and products. We therefore work to maintain and recover ecosystem services by means of contribution through business and by social contribution activities regarding protection of nature.

Of these activities, contribution through business promotes design and production activities that alleviate a corporation's burden on ecosystems, while providing energy-saving products.

Moreover, social contribution activities regarding protection of nature promotes ecosystem conservation, involving Group companies both in and outside Japan.

Relations between ecosystems and corporations

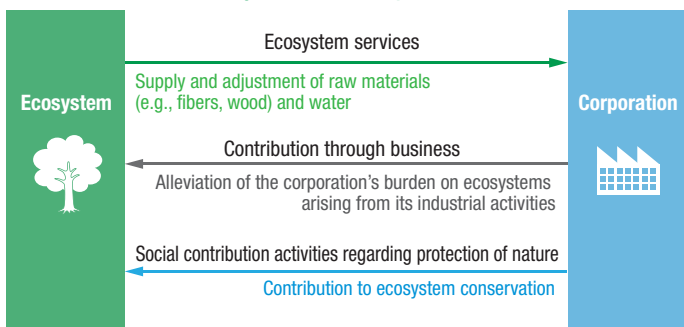

- Production depending on ecosystems
- ← Inhibition of negative effects (alleviation of corporate burdens on ecosystems)
- ← Increase in positive effects (contribution to ecosystem conservation)

Various efforts to conserve ecosystems

The Hitachi Group created a Menu of Ecosystem Conservation Activities, which specifies its value chains and other corporate activities, in fiscal 2016. This menu of activities consists of 116 items and from which the Hitachi Appliances Group set the total number of new activities conducted since fiscal 2016 as a target for its ecosystem conservation activities.

The Hitachi Appliances Group's Menu of Ecosystem Conservation Activities of fiscal 2016 was applied to five projects, as opposed to its target of two projects. Among its new main projects were the planting of coral reefs by volunteer employees, introduction of photovoltaic generation in the factory, and measurement of the underground water level on the premises of the factory.

Overview of the Hitachi Group's Menu of Ecosystem Conservation Activities

	Category	Typical projects	Number of items	
Factories	Production	Reduction in the consumption of unrecyclable resources	4	
	Transportation	Use of eco-friendly packing materials	7	
	Collection, disposal, recycling	Reduction of hazardous substances contained in products	2	
	Product planning, development, design	Estimation of the effects of products on biodiversity during their life cycle during research and development and, as necessary, the reduction thereof	3	
	Premises management	Adoption of native species, installation of a biotope	17	
	Water use	Use of rainwater	1	
Value chains	Investment and takeover	Confirmation of effects on biodiversity when deciding to invest or take over a new company, and implementation of measures to minimize those effects	1	
	Entry and extension	Incorporation of biodiversity considerations into the criteria of investment judgment	1	
	Business development	Development and project deployment of products and services that purify water, air, and soil	1	
	Procurement	Priority procurement of paper and other stationery goods proven to be eco-friendly	17	
	Transportation	Implementation of measures regarding ballast water during marine transportation	2	
	Sales	Sales promotion for eco-friendly products	9	
	Collection, disposal, recycling	Reuse and recycling of parts	7	
	Entire value chains	Promotion of the introduction of renewable energy	1	
	Community	Communication	Promotion of employees' community services	3
		Social contribution	Planting in the community	12
Water use with consideration given to stream ecosystems	Water intake	Biota observation or information collection (effects of water intake on ecosystems)	14	
	Drainage	Setting and observation of management indicators of the biota (species and numbers of living things inhabiting the region)	14	

Examples of ecosystem conservation efforts

Coral planting

The seawater along the coast of Thailand is being heated up by global warming. Moreover, coral damage presumably due to this heating of seawater is becoming a significant problem.

Hitachi Consumer Products (Thailand), Ltd. planted coral offshore of Toei Ngam Beach, Sattahip, Chonburi Province, Thailand to protect

and restore coral on September 24, 2016. The project was joined by 30 employees with the cooperation of the Royal Thai Army, resulting in the successful planting of coral.

With this opportunity to protect and restore coral reefs, the participants learned the importance of protecting marine resources.



IV. Social Contribution Activities on Environment

1 Participation in the Hitachi Global Lights-off Campaign

The Hitachi Group joined Earth Hour,² an event sponsored by the World Wildlife Fund (WWF¹) on March 25, 2017 and turned off the Hitachi signs, office lights, lights on the premises of its manufacturing centers, and other lightings for one hour from 20:30 to 21:30 local time. This campaign has been conducted every year since fiscal 2014. The Hitachi Appliances Group also agreed to participate in this project and turned off the lights at its various factories.

The Ohme Works of Hitachi Appliances, Inc., which develops and manufactures fluorescent lamps, temporarily turned off its lights designed for service life tests on fluorescent lamps.

¹: Short for "World Wildlife Fund for Nature."

²: An international event where people throughout the world turn off their lights for one hour at the same time on the same day, thereby sharing their hopes to stop global warming and protect the global environment.

Ohme Works of Hitachi Appliances

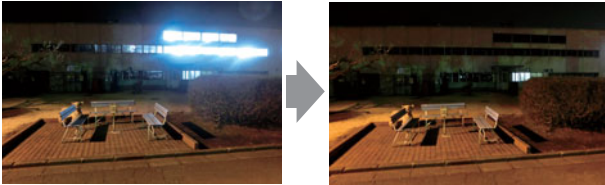

Before turning off the lights

After turning off the lights

2 Environmental lectures at a local elementary school

The Tochigi Works of Hitachi Appliances sent representatives to an elementary school in Tochigi-shi in November 2016. There they gave lectures on water to 80 fourth-year elementary school pupils.

The lectures began with an overview of the site area, products, and other details of the Tochigi Works, then provided a video presentation on how waste home electronics are recycled by Kantou Eco Recycle Co., Ltd. and how wastewater is purified at the wastewater treatment facility at the Tochigi Works.

After watching the video, the pupils used their self-made transparency meters to measure the turbidity of factory wastewater, added coagulant to factory wastewater, thereby settling particles in the wastewater, and actually observed how the water became purified. In so doing, they enjoyed learning what they were learning.



3 Cleaning at Kawarago Beach

The Taga Works of Hitachi Appliances, Inc. did some cleaning at nearby Kawarago Beach, Hitachi-shi, Ibaraki Prefecture on July 8, 2016.

This program has been carried out every year since 1968, spanning nearly half a century, and will be continued. On the day of the project, a total of about 100 people, including approx. 90 employees of the Taga Works and 10 locals, joined forces and removed garbage from the beach and thus cleaned the seashore.



4 Cleaning of the pedestrian bridges on Rojana Road

On December 26, 2016, Hitachi Compressor (Thailand), Ltd. cleaned the pedestrian bridges on Rojana Road, the main road near its factory located in Utthai, Ayuttaya Province, Thailand, in order to contribute to the community and improve the environmental awareness of its employees.

On the project day, 20 employees participated and cleaned a total of 14 pedestrian bridges, thereby covering about 20 kilometers.

The company will continue to contribute to the community as a member of it through various activities.



V. Environmental Communications

Exhibits displayed at the Appliance & Electronics World Expo (AWE)

Shanghai Hitachi Household Appliances Co., Ltd. displayed its exhibits at Appliance & Electronics World Expo (AWE) 2017, one of the region's largest exhibitions of home electronics sponsored by the China Household Electrical Appliances Association (CHEAA), held at the Shanghai New International Expo Center on March 9 to 11, 2017. The Hitachi booth displayed refrigerators, washing machines, rice cookers, and other appliances, and attracted many visitors.

At the 2017 China Appliance Award contest held at the hall on March 11, the drum-type washer/drier BD-FS9600C received the Best Environmental Award, and the refrigerator R-F9800XC received the Best of Innovation Award.

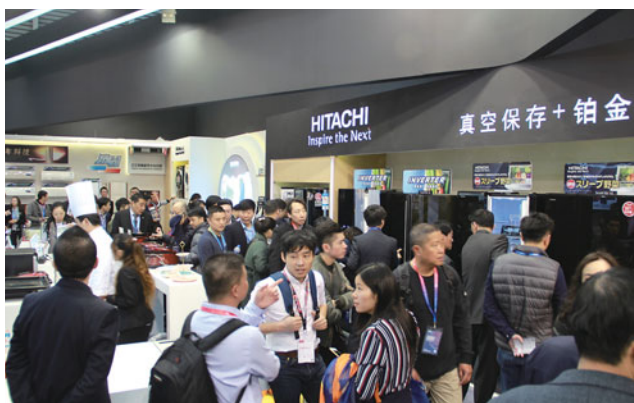

Hitachi booth at the Appliances & Electronics World Expo (AWE)



**Drum-type washer/drier
BD-FS9600C**



**Refrigerator
R-F9800XC**

Award-giving ceremony at the China Appliance Award contest and the products receiving the awards

Employee training

In 2009, the Hitachi Appliances Group received an order to remove certain information from its catalogs and other documentation on its refrigerators as per the Act against Unjustifiable Premiums and Misleading Representations. In connection with that order, the Group had caused great inconvenience to its customers and stakeholders. To prevent itself from ever forgetting the lesson that it learned there, since 2010 the Group has been inviting outside lecturers to give seminars and symposiums on ads and displays to its employees every year.

On October 4 in fiscal 2016, the Group invited Ms. Yukiko Furuya, permanent advisor to the Japan Association of Advisors, Consultants, and Counselors on Consumers' Lives to host a seminar on "Creating catalogs to prevent greenwashing."^{*1}

In producing this environmental report, the Group also sought advice from Ms. Furuya and Mr. Ikuo Sugimoto, president of the Citizens Environmental Foundation, in order to promote its efforts to prevent greenwashing and provide appropriate markings with a customer focus. The Group is planning and considering projects to promote even more appropriate environmental communication with customers.

*1: The act of pretending to be committed to environmental efforts even though inadequate or providing markings and advertisements that exaggerate the realities of a company's actual activities.



Seminar in action on "Producing catalogs to prevent greenwashing"



Meeting in action when producing Hitachi Appliances' Environmental Report 2017

▶ Company name	Hitachi Appliances, Inc.
▶ Main business	Development, manufacture and sales of kitchen and home appliances, lighting and housing equipment, and sales and services of refrigerating and air conditioning products
▶ President & Director	Toshiaki Tokunaga
▶ Capital Stock	20 billion yen (Hitachi, Ltd. 100%)
▶ Established	April 1, 2006 (Registered establishment date: November 26,1998)
▶ Consolidated revenues	419.5 billion yen (for the fiscal year ended March 31, 2017)
▶ Consolidated number of employees	8,500 (as of the end of March 2017)
▶ Website	http://www.hitachi-ap.co.jp/

Atago Office (Head Office)

Atago Office (Head Office)

Hitachi Atago Bldg., 15-12, Nishi Shimbashi 2-chome, Minato-ku, Tokyo
105-8410, Japan

Overseas Network [Home appliances]

Shanghai Hitachi Household Appliances Co., Ltd.

TEL:+86-21-5178-2188

29F, Tower B, City Center of Shanghai, No.100 Zunyi Road, Shanghai
200051, China

Hitachi Compressor (Thailand), Ltd.

TEL:+66-35-330819~32

1/65 Moo 5, Rojana Industrial Park, Tambol Kanham Amphur U-Thai,
Ayutthaya 13210, Thailand

Hitachi Consumer Products (Thailand), Ltd.

TEL:+66-3728-4000

610/1 Moo 9 Tambol Nongki Amphur Kabinburi, Prachinburi 25110, Thailand

Overseas Network [Refrigerating and Air conditioning products]

Hitachi-Johnson Controls Air Conditioning, Inc.

TEL:+81-3-6721-5567

New Pier Takeshiba South Tower, 16-1, Kaigan 1-chome, Minato-ku, Tokyo
105-0022, Japan

Factories in Japan

Tochigi Works Tochigi City, Tochigi Prefecture

Taga Works Hitachi City, Ibaraki Prefecture

Ome Works Ome City, Tokyo

Sales Divisions, Branches, and Marketing Offices in Japan (Air Conditioning System)

Hokkaido Maketing Branch	Kitanihon Branch Office
Fukushima Maketing Branch	Kanto & Overall Sales Branch Office
Hokuriku Branch Office	Chubu Branch Office
Kansai Branch Office	Chushikoku Branch Office
Shikoku Maketing Branch	Kyushu Branch Office

Sales Divisions, Branches, and Marketing Offices in Japan (Eco & Appliances)

Kitanihon Marketing Branch	Kanto Marketing Branch
Chubu Marketing Branch	Kansai Marketing Branch
Chushikoku Marketing Branch	Kyushu Marketing Branch

Group Companies in Japan

Hitachi Taga Technology, Ltd.

Niigata Hitachi Co., Ltd.

Hitachi Air Conditioning Kyushu Co., Ltd.

Hitachi Softec Co., Ltd.

Hitachi Air Conditioning Kanto Co., Ltd.

Hitachi Air Conditioning Kansai Co., Ltd.

Kanto Eco Recycle Co., Ltd.

Scope of Report

- Reporting Period: FY2016 (April 1, 2015 to March 31, 2017)
- Scope of Reporting: Hitachi Appliances, Inc. and its consolidated subsidiaries
(Where the scope is different from the above, describe it is so indicated.)
- How to set the base year data: JIS Q 14064-1:2010 "Greenhouse gases - Part 1: Specification with guidance at the organization level for quantification and reporting of greenhouse gas emissions and removals" is referred.
- Reporting cycle: Issued annually as an annual report
- Website: (Japanese version only) <http://www.hitachi-ap.co.jp/corporate/environment/>
- Guidelines referred: "Environmental Reporting Guidelines 2012" (Ministry of the Environment)
"Environmental Performance Indicators Guidelines for Businesses 2002" (Ministry of the Environment)
"Environmental Reporting Guidelines 2001 -With Focus on Stakeholders" (Ministry of Economy, Trade and Industry)

* For efforts for CSR of Hitachi Group, please see the Hitachi Sustainability Report.

Photo on the front page

Row of ginkgo trees on the premises of the Tochigi Works.

The Tochigi Works is turning itself into a factory that retains the natural scenery that it enjoyed when the facility was founded.

With its green open to the locals as well, the factory is familiar to them as a park and a factory.

Contact Address

Hitachi Appliances, Inc., Environment Promotion Department

Hitachi Atago Bldg., 15-12 Nishi Shimbashi 2-chome, Minato-ku, Tokyo 105-8410 Japan
TEL: +81-3-3502-2111 FAX: +81-3-3506-1438



Issued in October 2017